

1A Parts in this Box

Pièces dans cette boîte

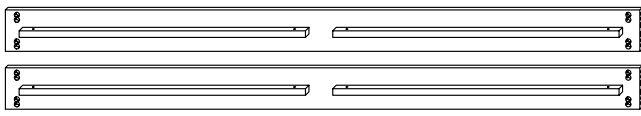

Stretcher Rails d'éirement x 2

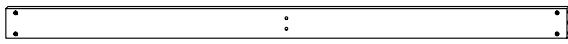

Center Rail Rail du centre x 1



Wooden Feet
Pied en bois x 3



Center Leg
Patte du centre x 1

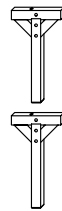

Legs
Patte x 2

Slats are Packed separately in Box 4

Les lattes sont empaquetées séparément dans la boîte 4

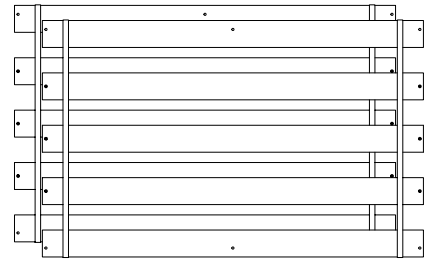

Set of Slats Ensemble de lattes x 2

1B Hardwares in this box

Quincaillerie incluse

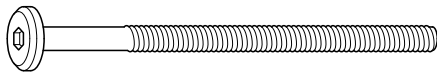

80mm Bolts
Vis (80mm) x 4

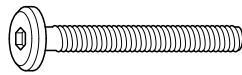

40mm Bolts
Vis (40mm) x 4

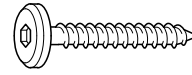

30mm Threaded Wood Bolt
Vis à bois (30mm) x 8

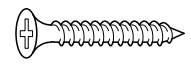

30mm Wood Screws
Vis à bois (30mm) x 12



Long Allen Key
Longue clef allen
x 1



ThumNut™
Boulons ThumNut™ x 8
Patent No. Brevet No.: US
6,457,923



Barrel Nuts
Écrous
x 4



M6 Wing Nuts
Écrous (M6)
x 2



Washer
Rondelle
x 4



Wooden Dowels
Goujons de bois
(Ø10 x 30mm)
x 2

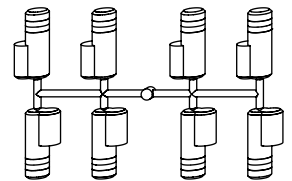

Set of 8 Plastic Dowels
Ensemble de 8 gougeons
en plastique x 1

1C Fit the Plastic Dowels to the Stretcher

Insérer le gougeons de plastique dans les rails

P-Series Bed (or Dual Series using the lower holes):

Lit de la série P (ou Duo série utilisant les trous du bas):

K-Series Bed or Dual Series using the upper holes:

Lit de la série K (ou Duo série utilisant les trous du haut):

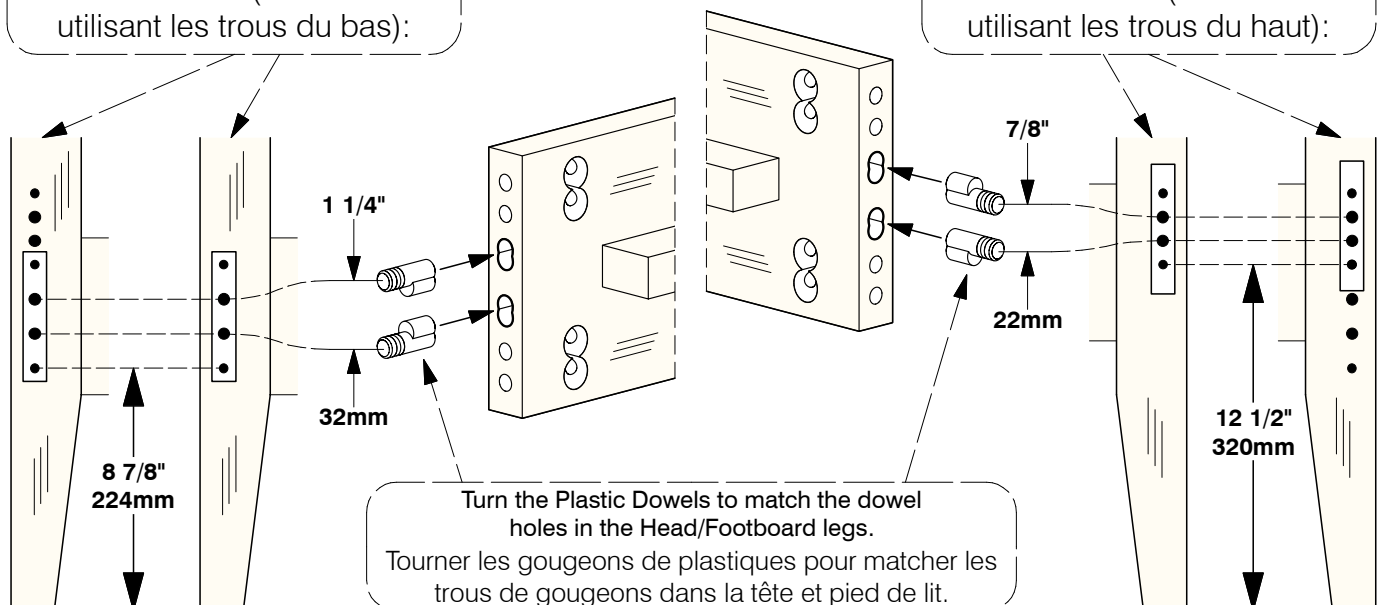

2A Attach the Rails to the Headboard and Footboard
Attacher les rails à la tête et au pied du lit

✓ **The Headboard and Footboard are packed in separate Boxes with Bolts and Wood Buttons.**

La tête et le pied du lit sont emballés dans des boîtes séparées avec les vis et les boutons de bois.

✓ **Leave the Bolts a bit loose, so it is easier to align the slats. Only after everything is put together should you tighten all the Bolts.**

Laisser les vis un peu lâche pour faciliter l'alignement des lattes. Une fois le tout mis en place serrer toutes les vis.

Use 2 People!

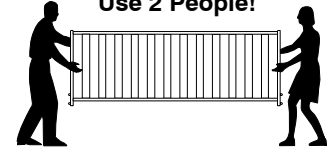

Il faut être 2 personnes!

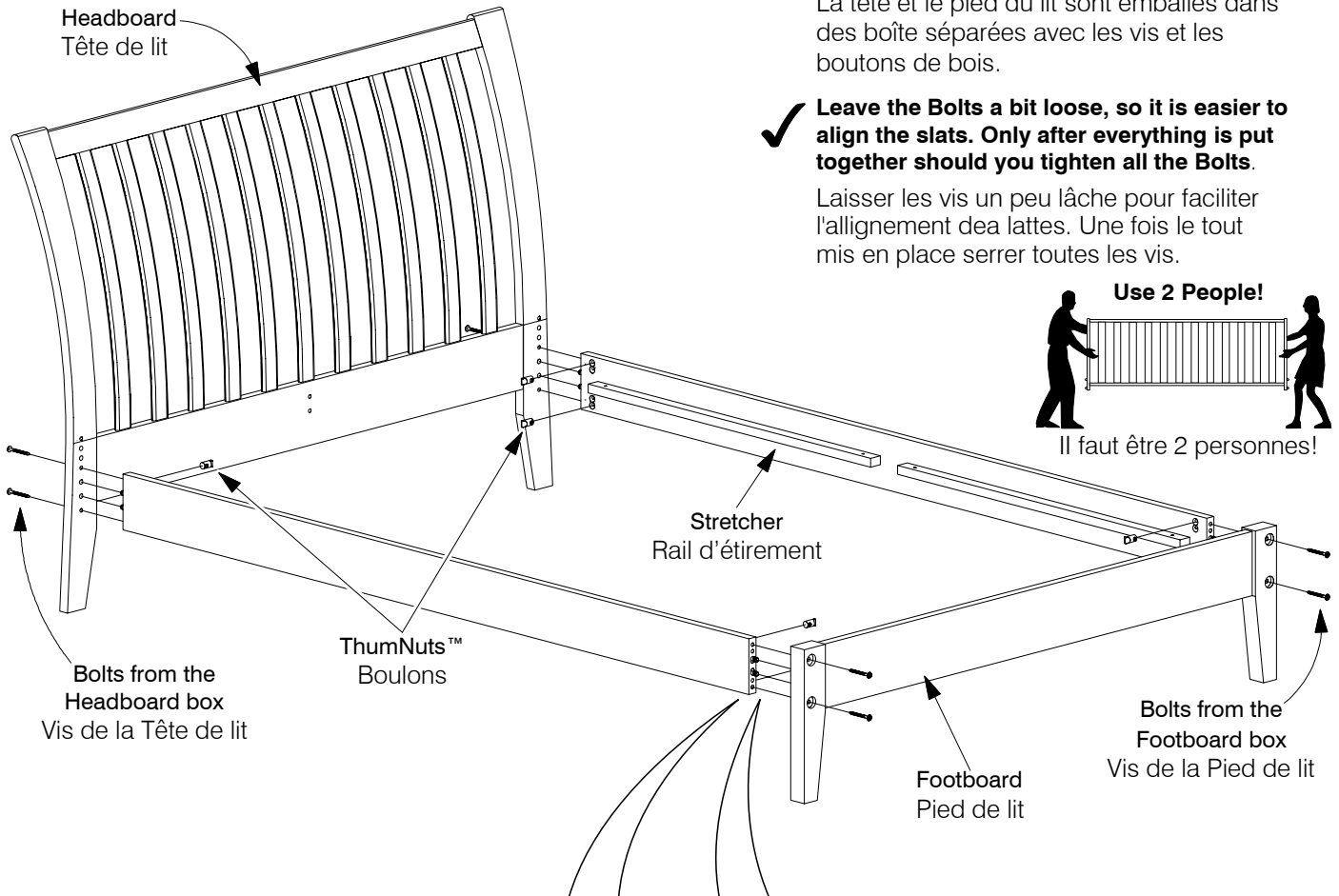

P-Series Bed
(or Dual Series using the lower holes):
Lit de la série P
(ou Duo série utilisant les trous du bas):

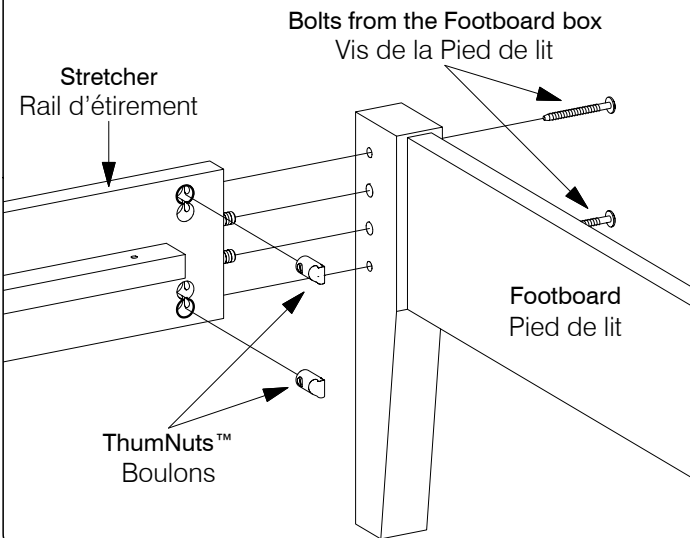

K-Series Bed
(or Dual Series using the upper holes):
Lit de la série K
(ou Duo série utilisant les trous du haut):

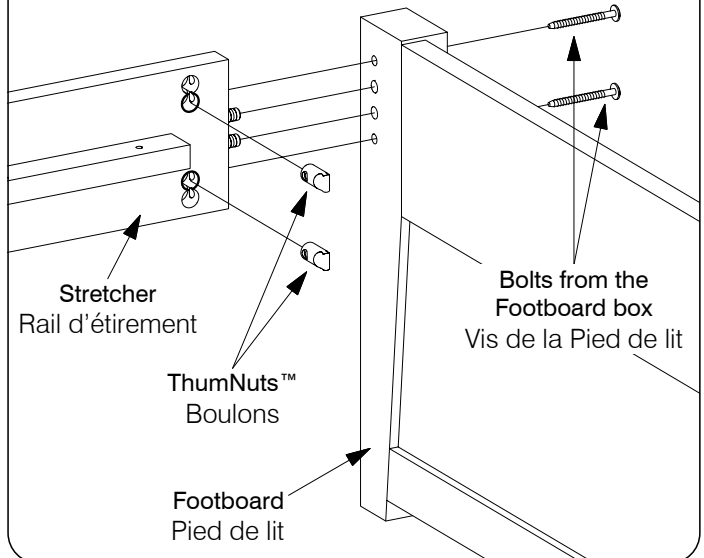

3A Fit the Legs to the Center Rail Adjuster les pattes au rail central

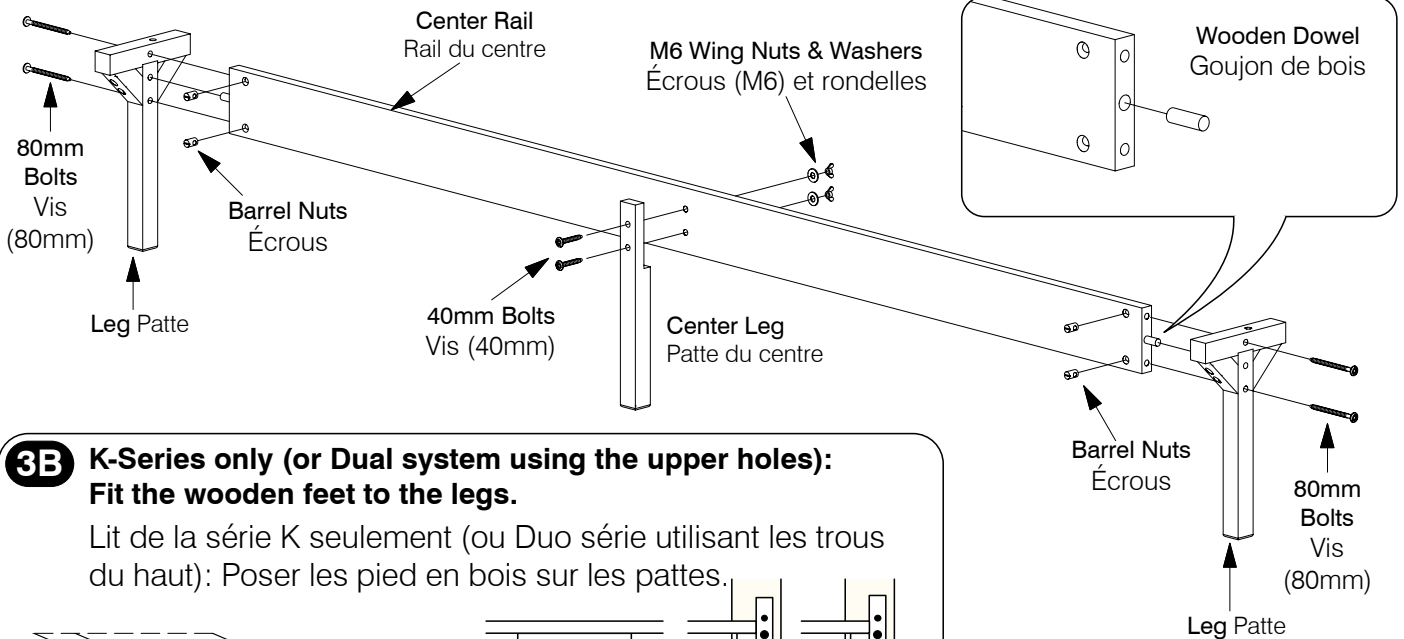

3B K-Series only (or Dual system using the upper holes):
Fit the wooden feet to the legs.

Lit de la série K seulement (ou Duo série utilisant les trous du haut): Poser les pied en bois sur les pattes.

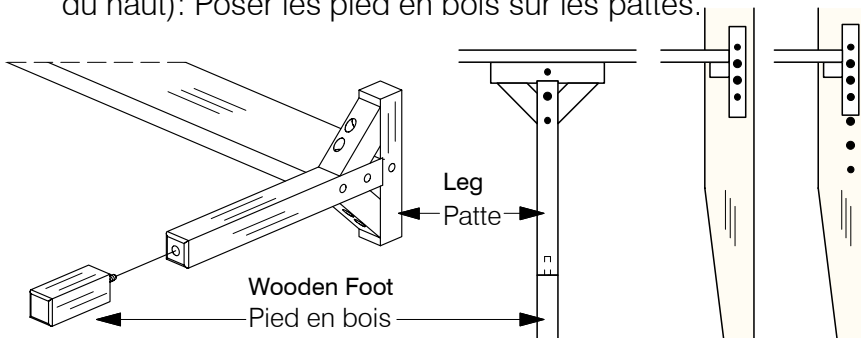

3C Fit one Set of Slats between the Stretchers
Mettre en ensemble de lattes entre les rails d'étirement

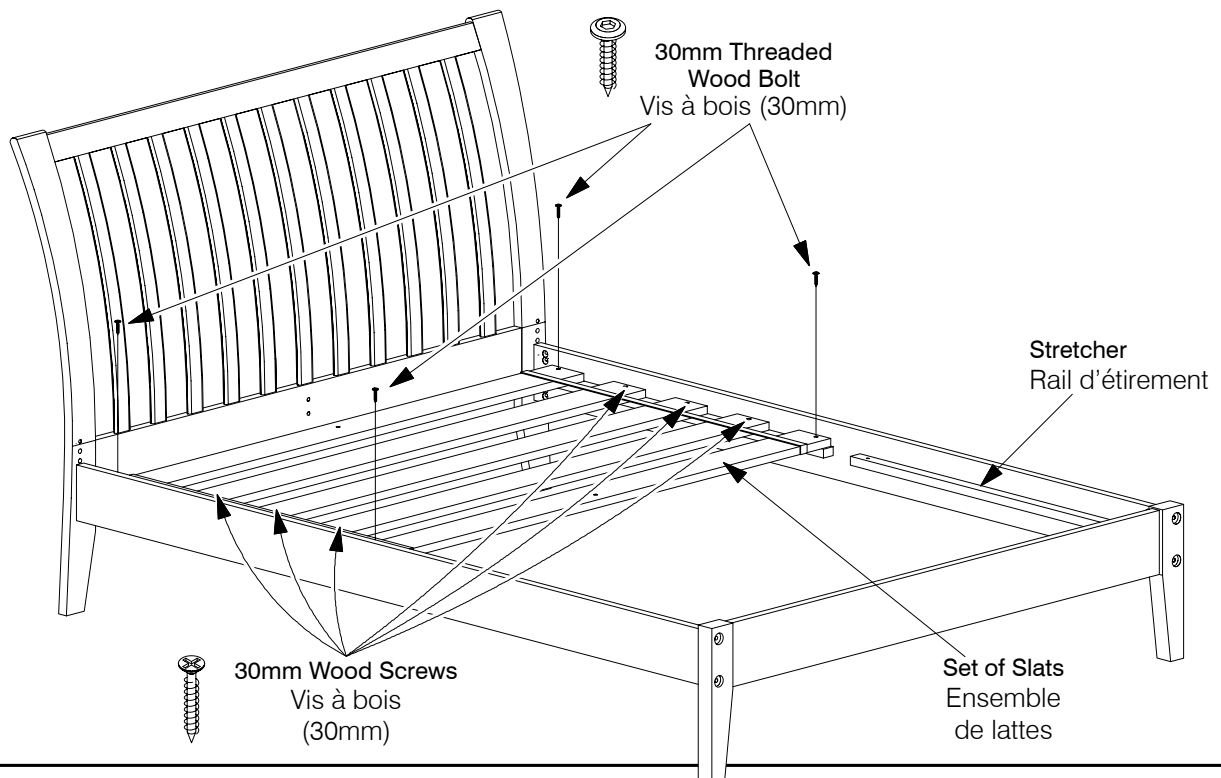

4A Fix the Legs to the Center Rail Adjuster les pattes au rail central

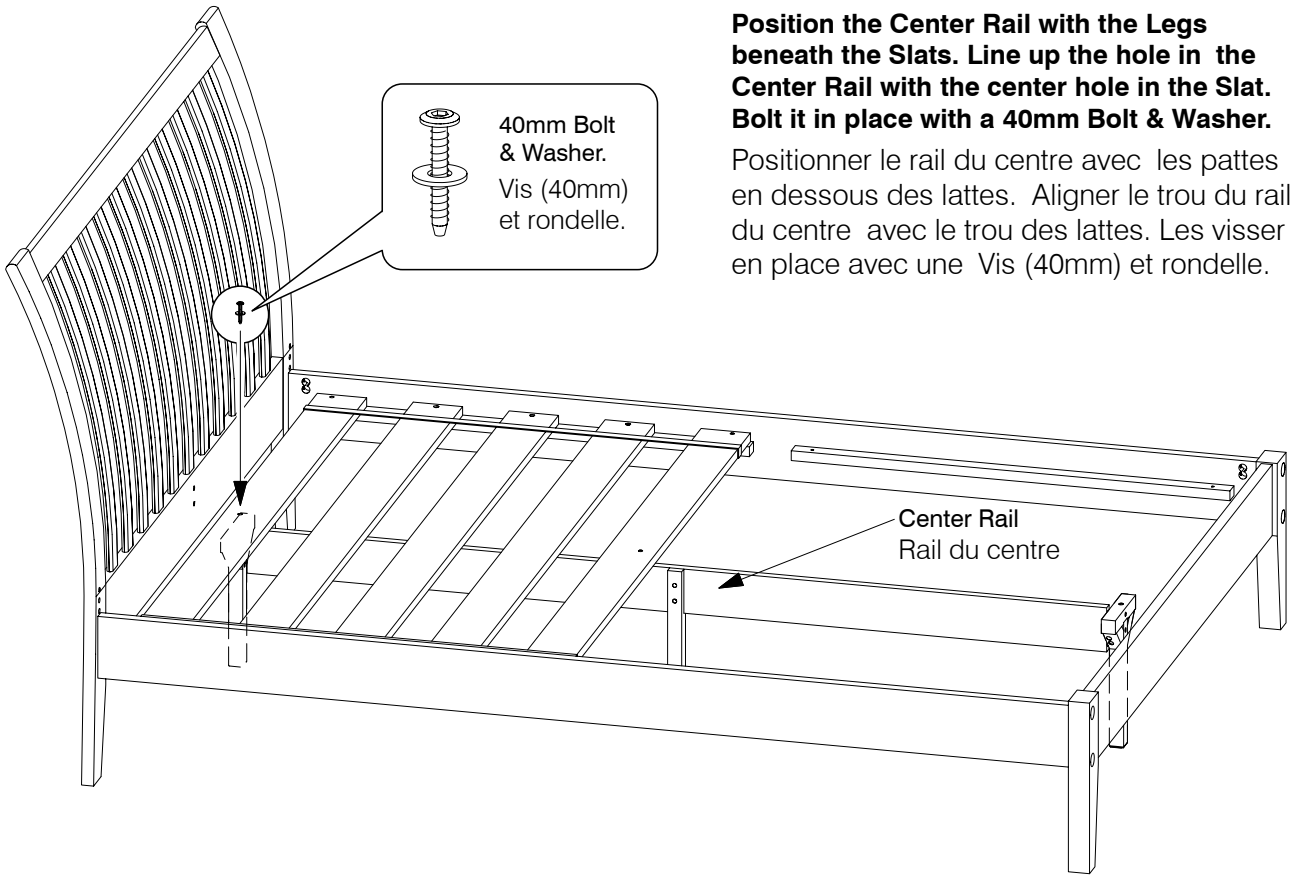

4B Fit the other Set of Slats between the Stretchers
Mettre l'autre ensemble de lattes entre les rails d'étirement

✓ **NOTE: All Slats must be screwed down.**
NOTE: Il est essentiel de vissez toutes les lattes.

